

VASCA  
BATHTUB

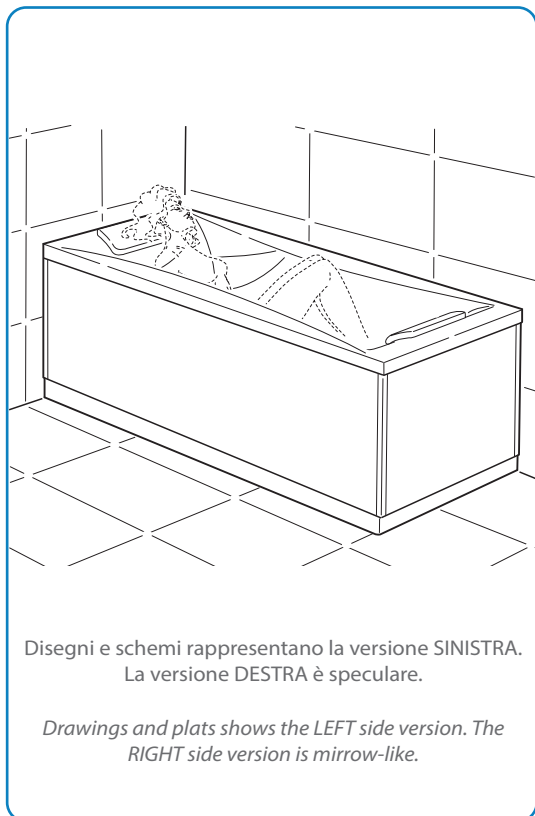

DESIGN - 170x75

Dimensioni "cm" - tolleranza ±5mm  
Dimensions "cm" - tolerance ±5mm

VASCA - BATHTUB

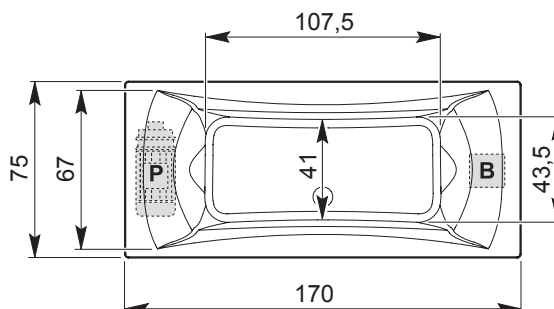
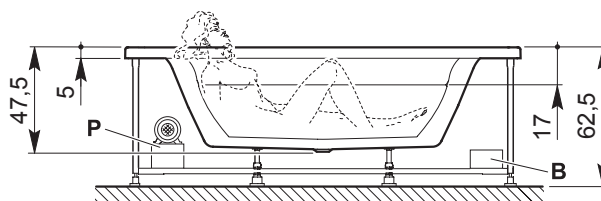

Le quote si riferiscono alla sola vasca, pannelli esclusi  
The dimensions refer only the bathtub, excluded panels



**P**  
Pompa/Pump

**B**  
Blower



Senza sistema  
without system

MINIMAL MIX  
< B+P >

DIGITAL PLUS<sup>2</sup>  
< B+P >

OXYGEN POOL PLUS  
< B >

Senza sistema  
without system



MINIMAL MIX



DIGITAL PLUS<sup>2</sup>



OXYGEN POOL PLUS



Dati tecnici (B = blower aria) (P = pompa acqua)	Technical data (B= air blower) (P= water pump)		Senza sistema without system	MINIMAL MIX	DIGITAL PLUS <sup>2</sup>	OXYGEN POOL PLUS
Tensione	Voltage	V~	--	230	230	230
Frequenza	Frequency	Hz	--	50	50	50
Potenza assorbita totale	Total power absorption	W	--	1000	1000	1040
Potenza assorbita pompa	Pump power absorption	W	--	550	550	--
Potenza assorbita blower	Blower power absorption	W	--	450	450	1000
Potenza mantenim. tempertura	Temp. maintenance absorb.	W	--	--	--	--
Ossigeno	Oxygen	W	--	--	--	40
Corrente massima	Max current	A	--	2,5	2,5	2,5
Allaccio acqua fredda e calda <sup>(1)</sup>	Cold and hot water fittings <sup>(1)</sup>		1/2"	1/2"	1/2"	1/2"
Scarico	Waste trap	ø mm	40	40	40	40
Cavo alimentazione	Power cable					
Cavo equipotenziale	Equipotent. cable	mt	--	2	2	2
Pressione di rete <sup>(2)</sup>	Operatin pressure <sup>(2)</sup>	atm	2÷4	2÷4	2÷4	2÷4
Portata acqua	Water delivery	l/min	8÷13	8÷13	8÷13	8÷13
Peso netto <sup>(±5 kg)</sup>	Net weighth <sup>(±5 kg)</sup>	kg	50	60	60	55
Volume acqua	Water volume	l	210	210	210	210

<sup>(1)</sup> Prevedere due tubi flessibili

<sup>(2)</sup> Per pressioni superiori a 5 bar installare un riduttore di pressione a monte della tubatura.

<sup>(1)</sup> To preview two flexible pipes.

<sup>(2)</sup> If the water pressure exceeds 5 bars, a pressure reducer should be fitted upstream from the feed pipe.

**Schema di installazione**  
**Installation plan**

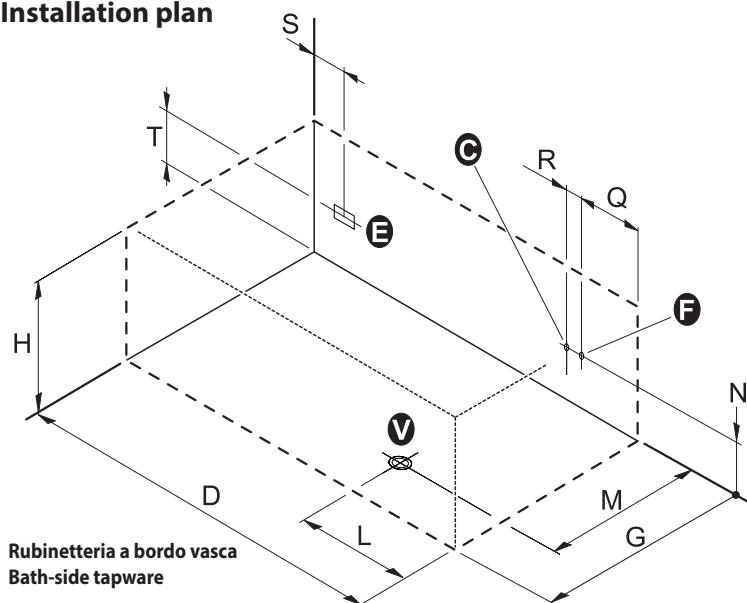

**Rubinetteria a bordo vasca**  
**Bath-side tapware**

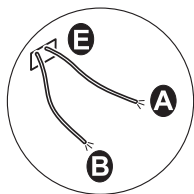

Versione "Senza sistema":  
**NO** predisposizioni "A" - "B" - "E"  
"Without system" version:  
**NO** predispositions "A" - "B" - "E"

Versione "Senza sistema"  
+ **SOUNDLIGHT SYSTEM** (opzionale):  
**SI** predisposizioni "A" - "B" - "E"  
"Without system" version  
+ **SOUNDLIGHT SYSTEM** (opzionale):  
**YES** predispositions "A" - "B" - "E"

**Rubinetteria a muro**  
**Wall-mounted tapware**

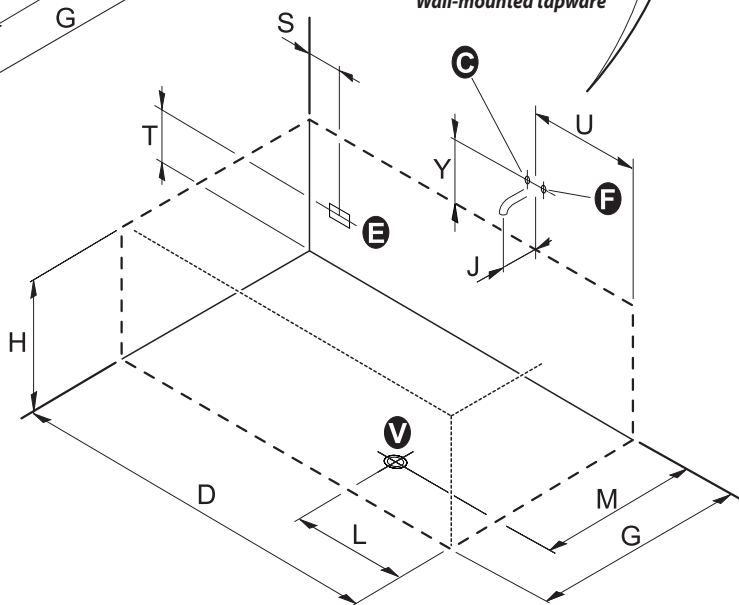

Il disegno rappresenta la versione SINISTRA. La versione DESTRA è speculare.  
The drawing show the LEFT side version. The RIGHT side version is mirror-like.

- A** - Allaccio elettrico per idromassaggio IPX5 (scatola con pressacavo PG13,5) Tensione 230V CA (max) Uscita cavo alimentaz. mt.2 tipo H05-3x2,5 mm<sup>2</sup> o 3x4,0 mm<sup>2</sup> (a seconda del sistema)
- B** - Uscita cavo equipotenziale - lunghezza 2 mt
- C** - Attacco acqua calda per rubinetteria 1/2"
- F** - Attacco acqua fredda per rubinetteria 1/2"
- E** - Area cavi alimentazione elettrica
- V** - Scarico a pavimento ø 40mm

- A** - Electrical connect. for IPX5 box (PG13,5 junction box with cable seal) 230 V AC (max.) Voltage 2 m. power cable output, H05-3x2,5 mm<sup>2</sup> o 3x4,0 mm<sup>2</sup> type (based on the system type).
- B** - Equipotential bonding conductor output - length 2mt
- C** - Hot water fitting for 1/2" tapware
- F** - Cold water fitting for 1/2" tapware
- E** - Line cord area
- V** - ø40mm drain fitting

Misure sono in "cm"  
Measurement in "cm"

<b>D</b> =	170	<b>R</b> =	8
<b>G</b> =	75	<b>S</b> =	15
<b>L</b> =	90	<b>T</b> =	35
<b>M</b> =	60	<b>U</b> =	35
<b>N</b> =	35	<b>Y</b> =	13
<b>P</b> =	62,5	<b>J</b> =	16
<b>Q</b> =	20		

L'installazione deve avvenire a pavimento e pareti finite.

Installation should occur once both the floor and walls are completed.

Accertarsi che l'impianto elettrico dello stabile sia conforme alle norme CEI 64.8 e protetto da un interruttore differenziale accertandosi che l'impianto di messa a terra sia efficiente e conforme alle disposizioni CEI. Il collegamento elettrico dell'impianto idromassaggio, va eseguito in modo fisso e permanente e deve essere controllato da un interruttore omipolare con apertura dei contatti di almeno 3 mm, ed avere un potere di interruzione pari a 16A o 25A (a seconda del tipo di sistema), posto fuori dalle zone 0,1,2,3 e comunque lontano da possibili erogazioni o spruzzi d'acqua. Il cavo di alimentazione alla centralina, deve essere del tipo H05 a tre conduttori di sezione non inferiore a 2,5 mm<sup>2</sup> o 4,0 mm<sup>2</sup> (a seconda del tipo di sistema). Per il passaggio nelle pareti di detto cavo, usare l'apposito tubo corrugato di tipo PT. La responsabilità del Costruttore decade nel caso in cui i componenti elettrici dell'apparecchio, vengano manomessi o sostituiti con ricambi non originali e/o non riconosciuti conformi dal Costruttore.

Make sure the building electrical installation conforms to the EIC 64.8 standard and that it is protected by a magnetic circuit breaker, ascertaining also that the grounding terminal is efficient and fully compliant with IEC provisions. The electrical connection of the bathtub shall be carried out permanently and be monitored by a single-pole switch, whose contacts can open 3mm at least and featuring a cut-out capacity equal to 16A or 25A (based on the system type), located outside areas 0, 1, 2 and 3 and at any rate, as far as possible from water supply or jets. The power-cord to the controller must be H05 with a three conductor cross-section is not less than 2,5mm<sup>2</sup> or 4,0 mm<sup>2</sup> (based on the system type). To drive the cord through the walls, use the appropriately supplied PT corrugated pipe. This warranty is void if failure has resulted from the electrical components of the appliance being either tampered with or replaced by second-hand spare parts, and/or spare parts whose conformity is not acknowledged by the manufacturer.

**IL COSTRUTTORE NON E' RESPONSABILE PER I DANNI DOVUTI AD UNA ERRATA O NON CONFORME INSTALLAZIONE.**

IN NO EVENT SHALL THE MANUFACTURER BE LIABLE FOR ANY DAMAGES WHATSOEVER THAT MAY ARISE FROM INAPPROPRIATE AND NON-COMPLIANT INSTALLATION PROCEDURES. I dati e le caratteristiche indicate non impegnano la SFA S.p.A., che si riserva il diritto di apportare tutte le modifiche ritenute opportune senza obbligo di preavviso o sostituzione. Neither the information nor the characteristics reported are binding for SFA S.p.A. which reserves the right to make any improvements, as deemed necessary, without notice or with no liability to replacement.

**VASCA  
BATHTUB**

**DESIGN - 170x75**

**LEGENDA RUBINETTERIA  
TAPWARE KEY**

Rubinetteria (a seconda del modello)  
Tapware (according to the model)



**Smart**



**Smart Plus**



**Drop**

(Termostatica o Meccanica)  
(Thermostatic or Mechanical)



**Cascata  
Waterfall**



**Cascata Drop  
Drop Waterfall**

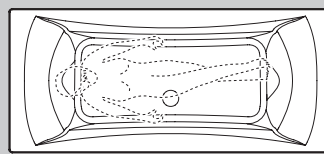
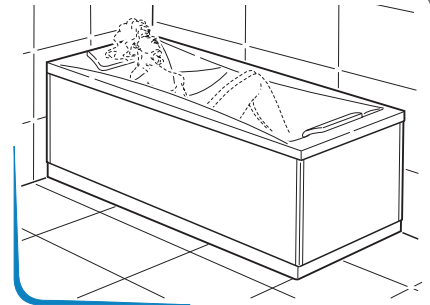

**LEGENDA SISTEMI  
SYSTEMS KEY**



**Comandi Minimal Mix  
Minimal Mix controls**



**Comandi Oxygen Pool Plus  
Oxygen Pool Plus controls**



**Tastiera Digital Plus²  
Digital Plus² keyboard**



**Cromoterapia  
Chromotherapy**



**Senza sistema  
without system**

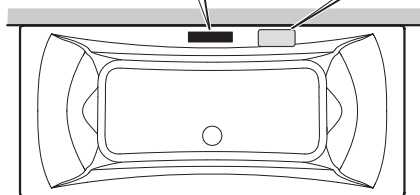
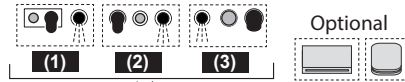

**MINIMAL  
MIX**

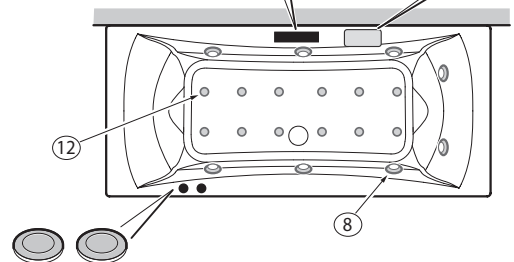
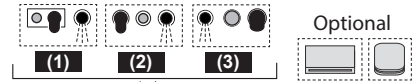

**DIGITAL  
PLUS²**

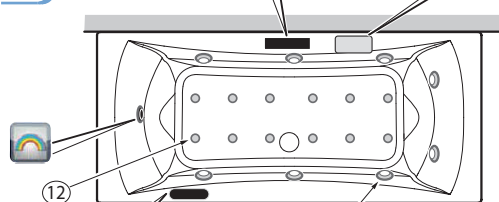
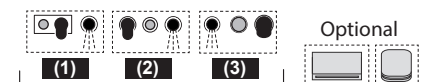

**OXIGEN  
POOL PLUS**

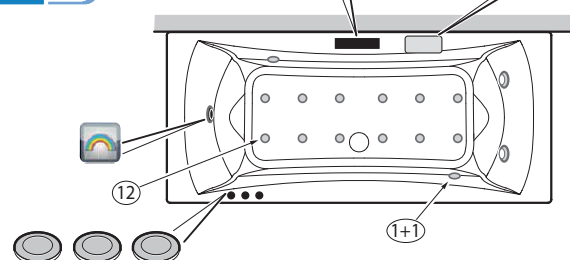
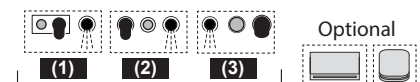

VASCA  
BATHTUB

DESIGN - 180x80



Dimensioni "cm" - tolleranza ±5mm  
Dimensions "cm" - tolerance ±5mm

VASCA - BATHTUB

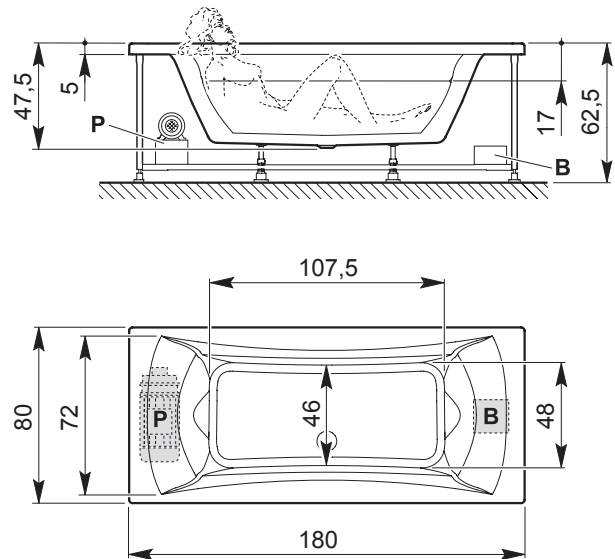

Le quote si riferiscono alla sola vasca, pannelli esclusi  
The dimensions refer only the bathtub, excluded panels

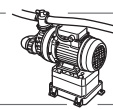

**P**  
Pompa/Pump



**B**  
Blower

Senza sistema  
without system

MINIMAL MIX  
< B+P >

DIGITAL PLUS<sup>2</sup>  
< B+P >

OXYGEN POOL PLUS  
< B >

Senza sistema  
without system



MINIMAL MIX

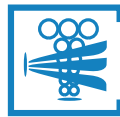

DIGITAL PLUS<sup>2</sup>



OXYGEN POOL PLUS



Dati tecnici (B = blower aria) (P = pompa acqua)	Technical data (B= air blower) (P= water pump)		Senza sistema without system	MINIMAL MIX	DIGITAL PLUS <sup>2</sup>	OXYGEN POOL PLUS
Tensione	Voltage	V~	--	230	230	230
Frequenza	Frequency	Hz	--	50	50	50
Potenza assorbita totale	Total power absorption	W	--	1000	1000	1040
Potenza assorbita pompa	Pump power absorption	W	--	550	550	--
Potenza assorbita blower	Blower power absorption	W	--	450	450	1000
Potenza mantenim. tempertura	Temp. maintenance absorb.	W	--	--	--	--
Ossigeno	Oxygen	W	--	--	--	40
Corrente massima	Max current	A	--	2,5	2,5	2,5
Allaccio acqua fredda e calda <sup>(1)</sup>	Cold and hot water fittings <sup>(1)</sup>		1/2"	1/2"	1/2"	1/2"
Scarico	Waste trap	ø mm	40	40	40	40
Cavo alimentazione	Power cable					
Cavo equipotenziale	Equipotent. cable	mt	--	2	2	2
Pressione di rete <sup>(2)</sup>	Operatin pressure <sup>(2)</sup>	atm	2÷4	2÷4	2÷4	2÷4
Portata acqua	Water delivery	l/min	8÷13	8÷13	8÷13	8÷13
Peso netto <sup>(±5 kg)</sup>	Net weighth <sup>(±5 kg)</sup>	kg	60	70	70	65
Volume acqua	Water volume	l	230	230	230	230

<sup>(1)</sup> Prevedere due tubi flessibili

<sup>(2)</sup> Per pressioni superiori a 5 bar installare un riduttore di pressione a monte della tubatura.

<sup>(1)</sup> To preview two flexible pipes.

<sup>(2)</sup> If the water pressure exceeds 5 bars, a pressure reducer should be fitted upstream from the feed pipe.

**Schema di installazione**  
**Installation plan**

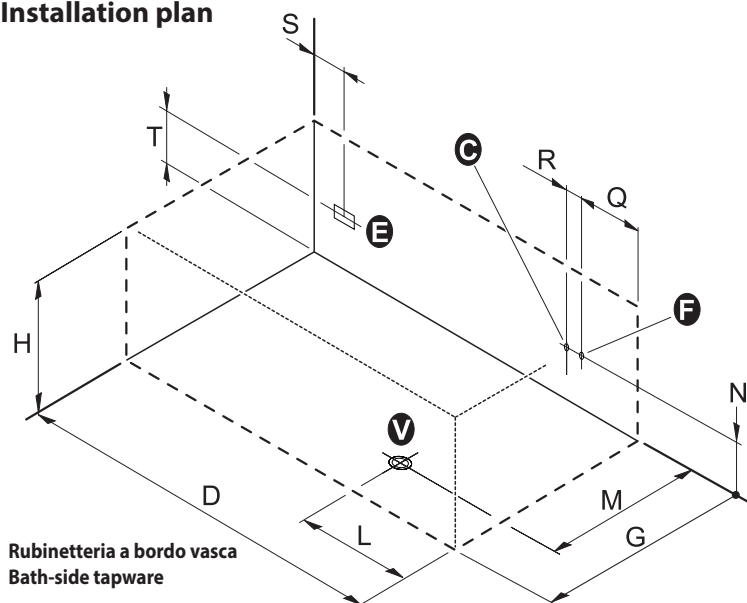

**Rubinetteria a bordo vasca**  
**Bath-side tapware**

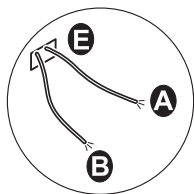

Versione "Senza sistema":  
**NO** predisposizioni "A" - "B" - "E"  
"Without system" version:  
**NO** predispositions "A" - "B" - "E"

Versione "Senza sistema"  
+ **SOUNDLIGHT SYSTEM** (opzionale):  
**SI** predisposizioni "A" - "B" - "E"  
"Without system" version  
+ **SOUNDLIGHT SYSTEM** (opzionale):  
**YES** predispositions "A" - "B" - "E"

Il disegno rappresenta la versione SINISTRA. La versione DESTRA è speculare.  
The drawing show the LEFT side version. The RIGHT side version is mirror-like.

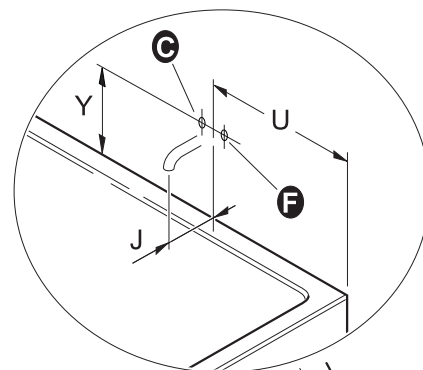

**Rubinetteria a muro**  
**Wall-mounted tapware**

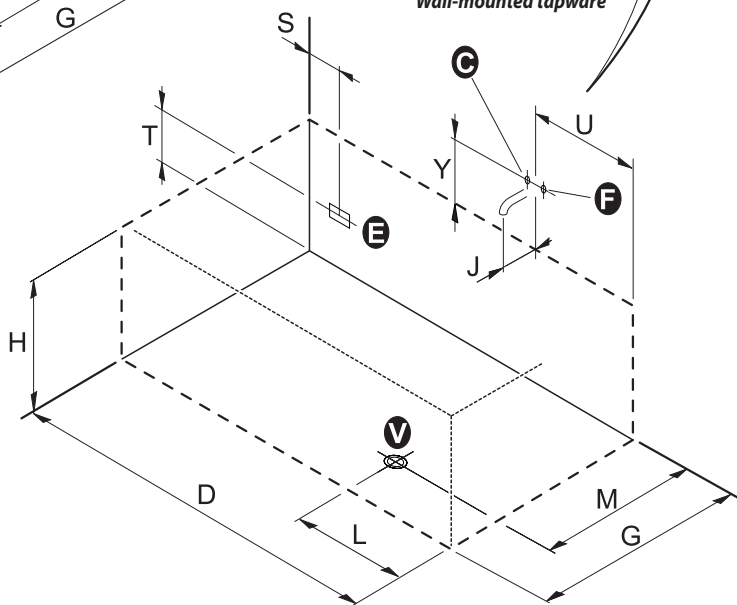

- A** - Allaccio elettrico per idromassaggio IPX5 (scatola con pressacavo PG13,5) Tensione 230V CA (max) Uscita cavo alimentaz. mt.2 tipo H05-3x2,5 mm<sup>2</sup> o 3x4,0 mm<sup>2</sup> (a seconda del sistema)
- B** - Uscita cavo equipotenziale - lunghezza 2 mt
- C** - Attacco acqua calda per rubinetteria 1/2"
- F** - Attacco acqua fredda per rubinetteria 1/2"
- E** - Area cavi alimentazione elettrica
- V** - Scarico a pavimento ø 40mm

- A** - Electrical connect. for IPX5 box (PG13,5 junction box with cable seal) 230 V AC (max.) Voltage 2 m. power cable output, H05-3x2,5 mm<sup>2</sup> o 3x4,0 mm<sup>2</sup> type (based on the system type).
- B** - Equipotential bonding conductor output - lenght 2mt
- C** - Hot water fitting for 1/2" tapware
- F** - Cold water fitting for 1/2" tapware
- E** - Line cord area
- V** - ø 40mm drain fitting

Misure sono in "cm"  
Measurement in "cm"

<b>D</b> =	180	<b>R</b> =	8
<b>G</b> =	80	<b>S</b> =	15
<b>H</b> =	63,5	<b>T</b> =	35
<b>L</b> =	60	<b>U</b> =	40
<b>M</b> =	65	<b>Y</b> =	13
<b>N</b> =	35	<b>J</b> =	13
<b>Q</b> =	30		

L'installazione deve avvenire a pavimento e pareti finite.

Installation should occur once both the floor and walls are completed.

Accertarsi che l'impianto elettrico dello stabile sia conforme alle norme CEI 64.8 e protetto da un interruttore differenziale accertandosi che l'impianto di messa a terra sia efficiente e conforme alle disposizioni CEI. Il collegamento elettrico dell'impianto idromassaggio, va eseguito in modo fisso e permanente e deve essere controllato da un interruttore omipolare con apertura dei contatti di almeno 3 mm, ed avere un potere di interruzione pari a 16A o 25A (a seconda del tipo di sistema), posto fuori dalle zone 0,1,2,3 e comunque lontano da possibili erogazioni o spruzzi d'acqua. Il cavo di alimentazione alla centralina, deve essere del tipo H05 a tre conduttori di sezione non inferiore a 2,5 mm<sup>2</sup> o 4,0 mm<sup>2</sup> (a seconda del tipo di sistema). Per il passaggio nelle pareti di detto cavo, usare l'apposito tubo corrugato di tipo PT. La responsabilità del Costruttore decade nel caso in cui i componenti elettrici dell'apparecchio, vengano manomessi o sostituiti con ricambi non originali e/o non riconosciuti conformi dal Costruttore.

Make sure the building electrical installation conforms to the EIC 64.8 standard and that it is protected by a magnetic circuit breaker, ascertaining also that the grounding terminal is efficient and fully compliant with IEC provisions. The electrical connection of the bathtub shall be carried out permanently and be monitored by a single-pole switch, whose contacts can open 3mm at least and featuring a cut-out capacity equal to 16A or 25A (based on the system type), located outside areas 0, 1, 2 and 3 and at any rate, as far as possible from water supply or jets. The power-cord to the controller must be H05 with a three conductor cross-section is not less than 2,5mm<sup>2</sup> or 4,0 mm<sup>2</sup> (based on the system type). To drive the cord through the walls, use the appropriately supplied PT corrugated pipe. This warranty is void if failure has resulted from the electrical components of the appliance being either tampered with or replaced by second-hand spare parts, and/or spare parts whose conformity is not acknowledged by the manufacturer.

**IL COSTRUTTORE NON E' RESPONSABILE PER I DANNI DOVUTI AD UNA ERRATA O NON CONFORME INSTALLAZIONE.**

IN NO EVENT SHALL THE MANUFACTURER BE LIABLE FOR ANY DAMAGES WHATSOEVER THAT MAY ARISE FROM INAPPROPRIATE AND NON-COMPLIANT INSTALLATION PROCEDURES. I dati e le caratteristiche indicate non impegnano la SFA S.p.A., che si riserva il diritto di apportare tutte le modifiche ritenute opportune senza obbligo di preavviso o sostituzione. Neither the information nor the characteristics reported are binding for SFA S.p.A. which reserves the right to make any improvements, as deemed necessary, without notice or with no liability to replacement.

**VASCA  
BATHTUB**

**DESIGN - 180x80**

**LEGENDA RUBINETTERIA  
TAPWARE KEY**

Rubinetteria (a seconda del modello)  
Tapware (according to the model)



**Smart**



**Smart Plus**



**Drop**

(Termostatica o Meccanica)  
(Thermostatic or Mechanical)



**Cascata  
Waterfall**



**Cascata Drop  
Drop Waterfall**

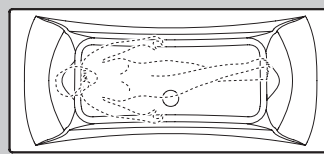
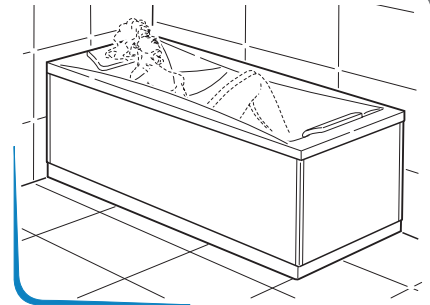

**LEGENDA SISTEMI  
SYSTEMS KEY**



**Comandi Minimal Mix  
Minimal Mix controls**



**Comandi Oxygen Pool Plus  
Oxygen Pool Plus controls**



**Tastiera Digital Plus²  
Digital Plus² keyboard**



**Cromoterapia  
Chromotherapy**



**Senza sistema  
without system**

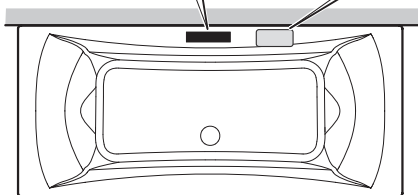
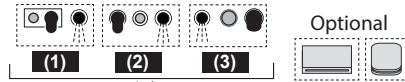

**MINIMAL  
MIX**

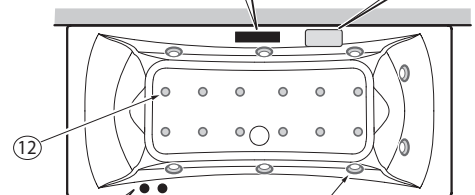
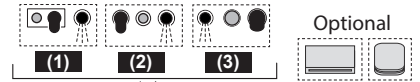

**DIGITAL  
PLUS²**

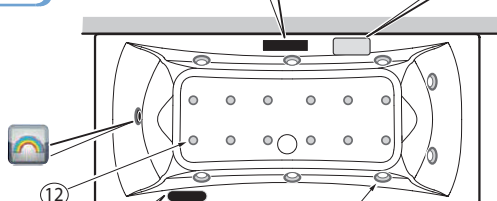
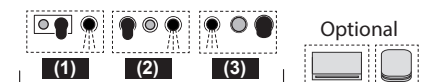

**OXIGEN  
POOL PLUS**

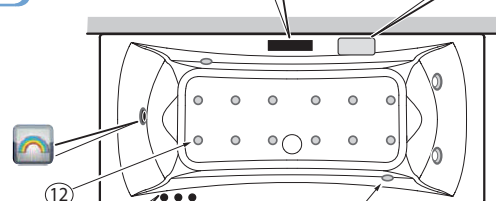
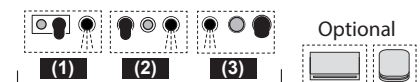

VASCA  
BATHTUB



DESIGN - 190x90

Dimensioni "cm" - tolleranza  $\pm 5$ mm  
Dimensions "cm" - tolerance  $\pm 5$ mm

VASCA - BATHTUB

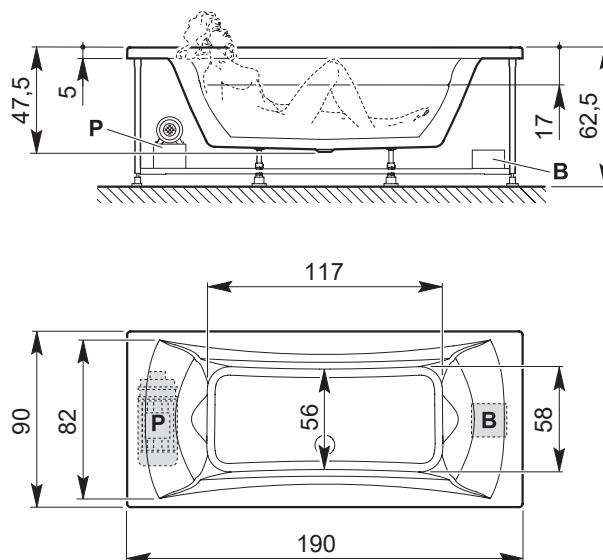

Le quote si riferiscono alla sola vasca, pannelli esclusi  
The dimensions refer only the bathtub, excluded panels

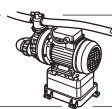

**P**  
Pompa/Pump

**B**  
Blower



Senza sistema  
without system

MINIMAL MIX  
< B+P >

DIGITAL PLUS<sup>2</sup>  
< B+P >

OXYGEN POOL PLUS  
< B >

Senza sistema  
without system



MINIMAL MIX



DIGITAL PLUS<sup>2</sup>



OXYGEN POOL PLUS



Dati tecnici (B = blower aria) (P = pompa acqua)	Technical data (B= air blower) (P= water pump)		Senza sistema without system	MINIMAL MIX	DIGITAL PLUS <sup>2</sup>	OXYGEN POOL PLUS
Tensione	Voltage	V~	--	230	230	230
Frequenza	Frequency	Hz	--	50	50	50
Potenza assorbita totale	Total power absorption	W	--	1000	1000	1040
Potenza assorbita pompa	Pump power absorption	W	--	550	550	--
Potenza assorbita blower	Blower power absorption	W	--	450	450	1000
Potenza mantenim. tempertura	Temp. maintenance absorb.	W	--	--	--	--
Ossigeno	Oxygen	W	--	--	--	40
Corrente massima	Max current	A	--	2,5	2,5	2,5
Allaccio acqua fredda e calda <sup>(1)</sup>	Cold and hot water fittings <sup>(1)</sup>		1/2"	1/2"	1/2"	1/2"
Scarico	Waste trap	ø mm	40	40	40	40
Cavo alimentazione	Power cable					
Cavo equipotenziale	Equipotent. cable	mt	--	2	2	2
Pressione di rete <sup>(2)</sup>	Operatin pressure <sup>(2)</sup>	atm	2÷4	2÷4	2÷4	2÷4
Portata acqua	Water delivery	l/min	8÷13	8÷13	8÷13	8÷13
Peso netto <sup>(±5 kg)</sup>	Net weighth <sup>(±5 kg)</sup>	kg	60	70	70	65
Volume acqua	Water volume	l	380	380	380	380

<sup>(1)</sup> Prevedere due tubi flessibili

<sup>(2)</sup> Per pressioni superiori a 5 bar installare un riduttore di pressione a monte della tubatura.

<sup>(1)</sup> To preview two flexible pipes.

<sup>(2)</sup> If the water pressure exceeds 5 bars, a pressure reducer should be fitted upstream from the feed pipe.

**Schema di installazione**  
**Installation plan**

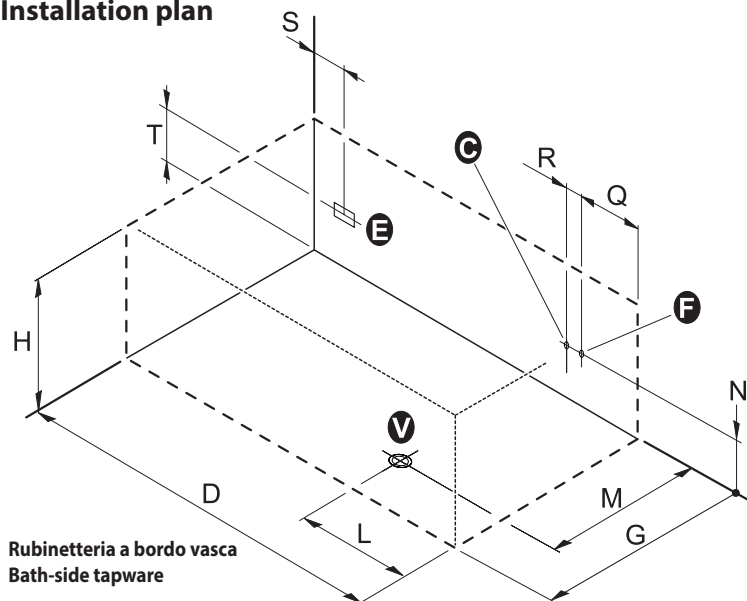

**Rubineria a bordo vasca**  
**Bath-side tapware**

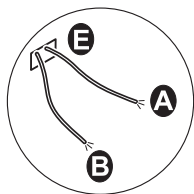

Versione "Senza sistema":  
**NO** predisposizioni "A" - "B" - "E"  
"Without system" version:  
**NO** predispositions "A" - "B" - "E"

Versione "Senza sistema"  
+ **SOUNDLIGHT SYSTEM** (opzionale):  
**SI** predisposizioni "A" - "B" - "E"  
"Without system" version  
+ **SOUNDLIGHT SYSTEM** (opzionale):  
**YES** predispositions "A" - "B" - "E"

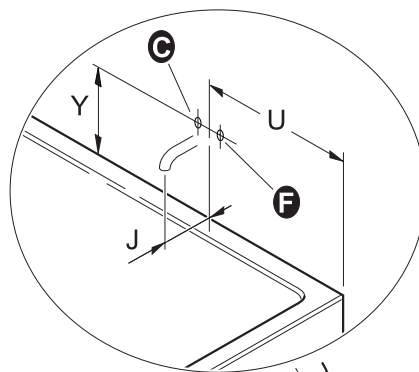

**Rubineria a muro**  
**Wall-mounted tapware**

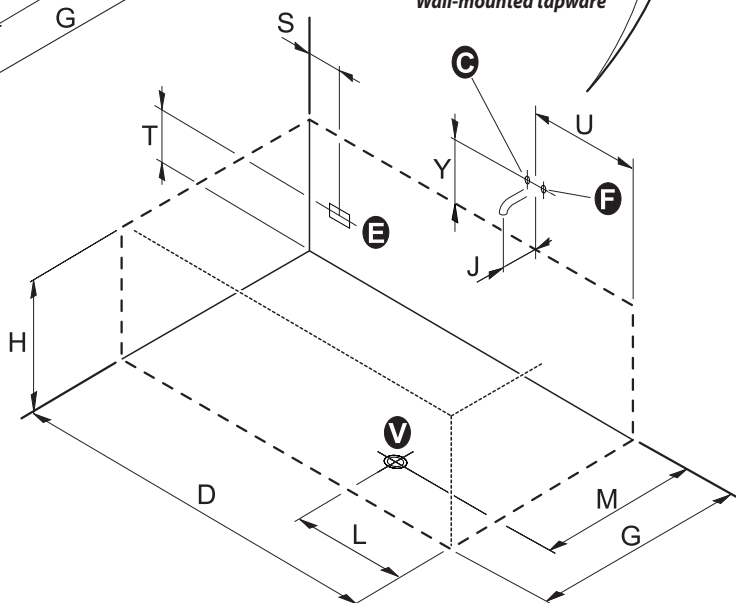

Il disegno rappresenta la versione SINISTRA. La versione DESTRA è speculare.  
The drawing show the LEFT side version. The RIGHT side version is mirror-like.

- A** - Allaccio elettrico per idromassaggio IPX5  
(scatola con pressacavo PG13,5) Tensione 230V CA (max)  
Uscita cavo alimentaz. mt.2 tipo H05-3x2,5 mm<sup>2</sup> o 3x4,0 mm<sup>2</sup>  
(a seconda del sistema)
- B** - Uscita cavo equipotenziale - lunghezza 2 mt
- C** - Attacco acqua calda per rubinetteria 1/2"
- F** - Attacco acqua fredda per rubinetteria 1/2"
- E** - Area cavi alimentazione elettrica
- V** - Scarico a pavimento ø 40mm

- A** - Electrical connect. for IPX5 box  
(PG13,5 junction box with cable seal) 230 V AC (max.)  
Voltage 2 m. power cable output, H05-3x2,5 mm<sup>2</sup> o 3x4,0 mm<sup>2</sup>  
type (based on the system type).
- B** - Equipotential bonding conductor output - lenght 2mt
- C** - Hot water fitting for 1/2" tapware
- F** - Cold water fitting for 1/2" tapware
- E** - Line cord area
- V** - ø40mm drain fitting

Misure sono in "cm"  
Measurement in "cm"

<b>D</b> =	190	<b>R</b> =	8
<b>G</b> =	90	<b>S</b> =	15
<b>H</b> =	63,5	<b>T</b> =	35
<b>L</b> =	60	<b>U</b> =	45
<b>M</b> =	65	<b>Y</b> =	13
<b>N</b> =	35	<b>J</b> =	13
<b>Q</b> =	35		

L'installazione deve avvenire a pavimento e pareti finite.

Installation should occur once both the floor and walls are completed.

Accertarsi che l'impianto elettrico dello stabile sia conforme alle norme CEI 64.8 e protetto da un interruttore differenziale accertandosi che l'impianto di messa a terra sia efficiente e conforme alle disposizioni CEI. Il collegamento elettrico dell'impianto idromassaggio, va eseguito in modo fisso e permanente e deve essere controllato da un interruttore omipolare con apertura dei contatti di almeno 3 mm, ed avere un potere di interruzione pari a 16A o 25A (a seconda del tipo di sistema), posto fuori dalle zone 0,1,2,3 e comunque lontano da possibili erogazioni o spruzzi d'acqua.

Il cavo di alimentazione alla centralina, deve essere del tipo H05 a tre conduttori di sezione non inferiore a 2,5 mm<sup>2</sup> o 4,0 mm<sup>2</sup> (a seconda del tipo di sistema). Per il passaggio nelle pareti di detto cavo, usare l'apposito tubo corrugato di tipo PT.

La responsabilità del Costruttore decade nel caso in cui i componenti elettrici dell'apparecchio, vengano manomessi o sostituiti con ricambi non originali e/o non riconosciuti conformi dal Costruttore.

Make sure the building electrical installation conforms to the EIC 64.8 standard and that it is protected by a magnetic circuit breaker, ascertaining also that the grounding terminal is efficient and fully compliant with IEC provisions. The electrical connection of the bathtub shall be carried out permanently and be monitored by a single-pole switch, whose contacts can open 3mm at least and featuring a cut-out capacity equal to 16A or 25A (based on the system type), located outside areas 0, 1, 2 and 3 and at any rate, as far as possible from water supply or jets.

The power-cord to the controller must be H05 with a three conductor cross-section is not less than 2,5mm<sup>2</sup> or 4,0 mm<sup>2</sup> (based on the system type). To drive the cord through the walls, use the appropriately supplied PT corrugated pipe.

This warranty is void if failure has resulted from the electrical components of the appliance being either tampered with or replaced by second-hand spare parts, and/or spare parts whose conformity is not acknowledged by the manufacturer.

**IL COSTRUTTORE NON E' RESPONSABILE PER I DANNI DOVUTI AD UNA ERRATA O NON CONFORME INSTALLAZIONE.**

IN NO EVENT SHALL THE MANUFACTURER BE LIABLE FOR ANY DAMAGES WHATSOEVER THAT MAY ARISE FROM INAPPROPRIATE AND NON-COMPLIANT INSTALLATION PROCEDURES. I dati e le caratteristiche indicate non impegnano la SFA S.p.A., che si riserva il diritto di apportare tutte le modifiche ritenute opportune senza obbligo di preavviso o sostituzione. Neither the information nor the characteristics reported are binding for SFA S.p.A. which reserves the right to make any improvements, as deemed necessary, without notice or with no liability to replacement.

**VASCA  
BATHTUB**

**DESIGN - 190x90**

**LEGENDA RUBINETTERIA  
TAPWARE KEY**

Rubinetteria (a seconda del modello)  
Tapware (according to the model)



**Smart**



**Smart Plus**



**Drop**

(Termostatica o Meccanica)  
(Thermostatic or Mechanical)



**Cascata  
Waterfall**



**Cascata Drop  
Drop Waterfall**

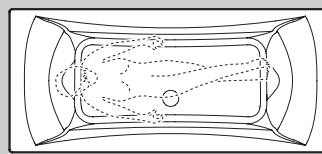
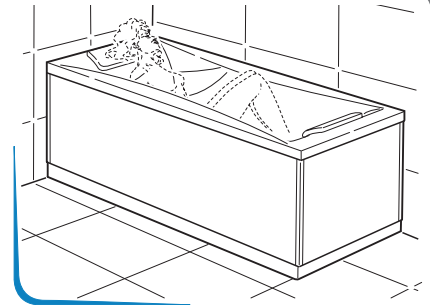

**LEGENDA SISTEMI  
SYSTEMS KEY**



**Comandi Minimal Mix  
Minimal Mix controls**



**Comandi Oxygen Pool Plus  
Oxygen Pool Plus controls**



**Tastiera Digital Plus²  
Digital Plus² keyboard**



**Cromoterapia  
Chromotherapy**



**Senza sistema  
without system**

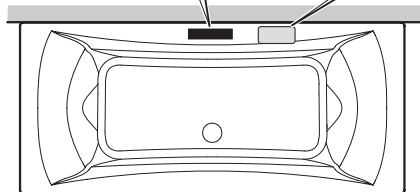
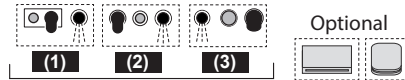

**MINIMAL  
MIX**

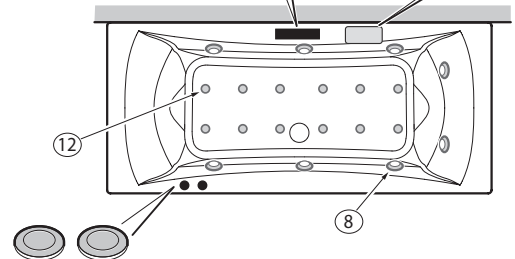
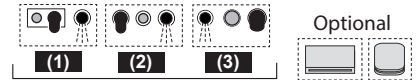

**DIGITAL  
PLUS²**

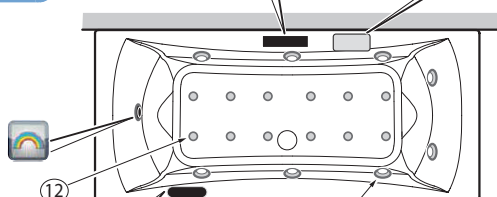
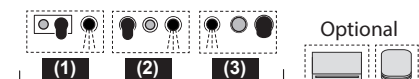

**OXIGEN  
POOL PLUS**

